

CONFIDENCE TODAY INSPIRES TOMORROW

CELEBRATING A
DECADE OF ACHIEVEMENT

RLB

Rider
Levett
Bucknall

Celebrating Ten Years **6**

Services **14**

Ten Year Round Table **16**

A Decade of Achievement
Across Key Sectors **22**



Cover photo: Channel 9 Melbourne, Australia

With a network that covers the globe and a heritage spanning over two centuries, Rider Levett Bucknall is a leading independent organisation in advisory services, cost management and quantity surveying, and project management.





Our achievements are renowned

from the early days of pioneering quantity surveying, to landmark projects such as the Sydney Opera House, HSBC Headquarters Building in Hong Kong, the 2012 London Olympic Games and CityCenter in Las Vegas.





We continue this successful legacy with our dedication

to the value, quality and sustainability of the built environment. Our innovative thinking, global reach, and flawless execution push the boundaries. Taking ambitious projects from an idea to reality.



CELEBRATING
TEN YEARS

10Y

CHAIRMAN'S MESSAGE



This year marks the tenth anniversary since Rider Levett Bucknall (RLB) formed a global practice in June 2007. It is my great honour and pleasure to congratulate all who have contributed to ten successful years of operations as RLB.

These commendations are extended to the many customers and partners who have continued to work with us on projects, adding to an extensive list of renowned achievements across Africa, Asia, Europe, the Middle East, North America and Oceania.

Since the formation of our global practice, RLB has enjoyed close working relationships with many in the local and international property and construction industry. The nature of our industry means that our futures are interdependent, as property and construction touches on all industries which operate worldwide. Accomplishments in each of RLB's 120 offices reflect success for us all.

Today, I proudly chair a dedicated and professional team of esteemed Global Board members comprising Julian Anderson, Kenneth Kwan, Stephen Lai, Russell Lloyd, Philip Lo, Stephen Mee, Andrew Reynolds and Peter Tulla.

RLB's focus on achieving another decade of success is evident through our involvement in many of the world's significant developments. While all projects are unique, and our participation may vary depending on our customers' needs, our commitment to performance and relationships is constant.

Congratulations on ten years of working together, and we look forward to another decade of contributing to the future.

A handwritten signature in black ink that reads "Ann Bentley". The signature is fluid and cursive.

ANN BENTLEY
RLB GLOBAL CHAIRMAN

THREE COMPANIES
BECOME ONE

3 → 1

Rider Hunt

Levett & Bailey
Chartered Surveyors



bucknell austin

Ten years ago we set out to provide a platform to enable 1,750 people across 65 offices to work together.

The Rider Levett Bucknall (RLB) global practice was launched in June 2007, in response to growing globalisation and increased customer requirements.

A key objective was to combine our experience and expertise to help our customers to achieve optimum value from their property and assets.

The RLB brand combined the strengths of three companies – Rider Hunt, Levett & Bailey and Bucknall Austin, committed to the quality delivery of three core services – advisory, cost management and quantity surveying, and project management.

We merged our names to reflect the new global practice, but we did not change our people, our principles or our philosophy.





RLB Global Board October 2016 Adelaide, Australia

A LONG HISTORY, EXTENSIVE GROWTH

Rider Levett Bucknall's long history can be traced back to a small firm of quantity surveyors, established in 1785 by Henry Cooper, the son of a master carpenter.

Based in Reading in England, Henry Cooper & Sons opened its London office in 1799, and worked on a number of engineering projects throughout the 19th Century, under the direction of the famous Victorian civil engineer, Isambard Kingdom Brunel.

Following two centuries of progression and growth, three major companies with common strengths and ambitions – Rider Hunt, Levett & Bailey and Bucknall Austin – pooled resources and expertise to form the Rider Levett Bucknall global practice in June 2007.

In the decade to follow we expanded our global portfolio into Africa with seven offices, established new business in Malaysia and Myanmar, opened new offices in Canada, China, the United Kingdom, the United States of America and the Philippines, and further consolidated new business across the Middle East and Caribbean. We continued to nurture strong long term partnerships locally and abroad and in doing so, we enhanced value for our customers.

Today, the same perspective and independent advice so valued by our founders has seen us become a global leader in the market. Over 3,600 staff in more than 120 offices across Africa, Asia, Europe, the Middle East, North America and Oceania help customers gain a greater understanding of the breadth of the company's experience and capability across a broad range of sectors.

Our customers benefit from our extensive knowledge of construction innovations and trends obtained through our global network. These insights add value to all aspects of our projects and management processes, and ensure customers will always be placed to optimise project outcomes.

Every day we contribute to cultural, economic, industrial, social and technological growth, through the consistent and reliable delivery of our projects to create a better tomorrow.

3,6000

STAFF

>120

OFFICES

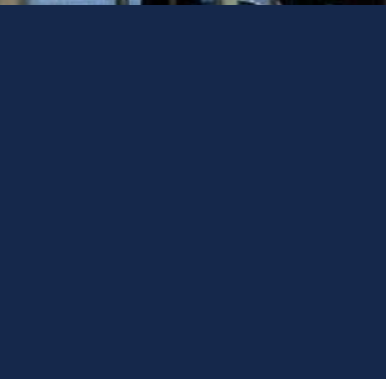
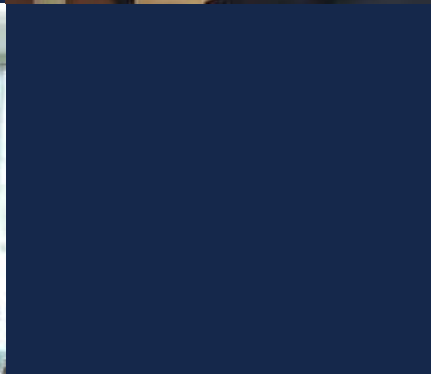



SERVICES



ADVISORY



COST MANAGEMENT AND
QUANTITY SURVEYING



PROJECT
MANAGEMENT

Forecasting a building's life cycle over 10, 25, 50, or even 100 years is a growing part of RLB's service offering, through cutting-edge tools such as the RELifing® of assets.

This holistic and wide-reaching approach covers a broad range of strategic issues, not just initial costs, including performance, maintenance, obsolescence and sustainability.

Our advisory services have developed in response to customer needs for a more sophisticated approach to the questions of conception, delivery, operation, and disposal of built assets throughout the property life cycle, in other words total asset management. Today, RLB's expertise and experience across the property cycle makes a real difference to a customer's corporate performance.

Cost management is at the core of RLB's services.

The service encompasses cost estimating, cost management, the production of tender and contract documents, the financial administration of building contracts and dispute resolution.

Cost management focuses on a customer's individual business needs to facilitate informed decisions regarding their property assets and provides strategic advice at the various stages of the construction project cycle to ultimately increase asset value.

RLB maintains and uses a large and comprehensive library of current and historical cost data and unit rates to produce detailed comprehensive cost estimates for all building types.

Beyond cost data and unit rates, cost management team members provide advice to building owners about business drivers, specific regional needs and sustainability practices.

At RLB, project management is a multi-faceted core service.

Customers commission RLB to: develop, rollout and manage programs; lead project teams; and to staff customer teams.

Project managers combine cost consultancy knowledge, project management ability and communication skills to run construction jobs from briefing to completion. They understand the balance needed to meet budget and milestones within timeframes without compromising quality.

RLB controls projects from the outset, setting out a control framework for the entire construction process. Using advanced computer systems and clear reporting procedures, projects are delivered to precise requirements.

The provision and structure of this service varies across RLB's operating regions, often depending on the individual customer's needs and building requirements. But the quality of the service remains the same.

TEN YEAR ROUND TABLE

The creation of RLB in 2007 brought a new world of opportunities as well as significant challenges. We recently met with the Global Board and regional leaders to ask them to share their thoughts on the past decade. In a candid, wide-ranging conversation they offered their insights on the 2007 merger, how RLB is positioned, the value we bring to customers, and their personal career pathways.



ANN BENTLEY
CHAIRMAN, GLOBAL BOARD;
DIRECTOR, UNITED KINGDOM



PHILIP LO
GLOBAL BOARD MEMBER;
CHAIRMAN, HONG KONG & CHINA



KENNETH KWAN
GLOBAL BOARD MEMBER;
MANAGING DIRECTOR,
HONG KONG & CHINA



JULIAN ANDERSON
GLOBAL BOARD MEMBER;
PRESIDENT, NORTH AMERICA



RUSSELL LLOYD
GLOBAL BOARD MEMBER;
PARTNER, UNITED KINGDOM



STEPHEN LAI
GLOBAL BOARD MEMBER;
MANAGING DIRECTOR,
HONG KONG & CHINA



PETER TULLA
GLOBAL BOARD MEMBER;
DIRECTOR, AUSTRALIA



SAM GRAHAM
DIRECTOR, MIDDLE EAST



NICOLAS SHEARD
CHIEF EXECUTIVE OFFICER,
RLB PENTAD, SOUTH AFRICA



STEPHEN MEE
GLOBAL BOARD MEMBER;
DIRECTOR, AUSTRALIA



ANDREW REYNOLDS
GLOBAL BOARD MEMBER;
DIRECTOR, UNITED KINGDOM



WHAT WAS THE OBJECTIVE OF FORMING A GLOBAL PRACTICE?

PL > There were many. Knowledge sharing, helping existing customers going outside local markets – and for us to reach out to new markets.

SL > Yes, I think it can achieve a synergy effect – where each party benefits more from the alliance than from individual efforts. It's simply pooling resources and providing opportunities for all of us to reach new markets and a new customer base.

PL > There's also the benefit of increased brand awareness.

SL > Definitely.

WHAT IS THE ROLE OF THE GLOBAL BOARD?

SM > It's basically to represent the various regions in one forum. This way, we can make collective decisions – on building and expanding the brand, as well as keeping the RLB brand as a top-ranked brand globally.

PT > Stephen is right, it's like a framework of governance – which includes legal and risk, strategic direction and planning. Also, I'd say expansion into new territories and brand management.

SG > The board provides the overall strategic direction for the business, supports new markets and is responsible for focusing the global vision of the practice. Although we are well established within certain Middle East markets, the greater region is still an emerging one for RLB with significant potential for future growth and success. As a regional director, I look to the board for guidance, support and assistance in coordinating the efforts of the global practice to take advantage of the opportunities on offer.

WHAT IS THE KEY STRENGTH OF THE GLOBAL PRACTICE?

JA > At its heart, I think it's linking people from across the world. But not just to support customers anywhere, I know for me, it's that personal experience – sharing ideas, seeing the different ways that construction is done. And of course, being exposed to different cultures. It really gives our team a broader view to find more creative solutions.

AR > I agree, I'd also say it's our scale, definitely – coupled with our independence. It's a powerful combination – it means we can offer a truly personal opinion. Providing this for our local markets is key, always adapting it to be relevant to our customers.

NS > It's also our experience in every sector without a doubt, and our expertise in specialised types of projects, we have the support, the global reach, it's all of that.

PL > For me – it's that collection of professionals with similar goals, with the same vision.

'The key strength of our global practice? Our scale coupled with our independence. It's a powerful combination.'

ANDREW REYNOLDS

‘None of our services have stood still in the last 10 years – digital technology, off-site manufacturing, smart buildings and a greater awareness of whole-life and sustainability – we’re working in a very different environment now.’

ANN BENTLEY

WHAT DRIVES YOU AS A GLOBAL BOARD MEMBER AND WHAT SATISFACTION DO YOU GET OUT OF IT?

AR > I take massive pride in representing our business and people on the Global Board. It’s amazing to see our people coming together to influence and contribute to the wider built environment.

PT > For me as well, it’s an honour to serve on the Global Board, as well as working with our great team in the Adelaide office.

AR > It’s pretty clear that our ongoing success is our drive for global collaboration. That positive, open culture creates almost like a framework for success for any venture and initiative. Personally, I really enjoy the opportunity to work with like-minded colleagues to take the business into the future.

SM > Yes, I find our real challenge is to unite our people – and for their skills to be shared from all parts of the world. One great example, was when we facilitated a Global BIM Workshop in Hong Kong with 26 of our people from across the world. For me personally, it was very satisfying – it really highlighted the skills we had within the group.

PT > As board members, we navigate through all the complexities of partnerships, opportunities, knowledge sharing etc. I get great satisfaction in co-creating these opportunities and solutions with my colleagues – it’s extremely rewarding.

AR > I really love delving into the many parts of the global practice and meeting all sorts of different people as well. It’s about listening and learning all the time really, and seeing how we can improve.

WHAT IS YOUR AMBITION NOW?

JA > Look, it’s the same as it was the day I became a shareholder – to contribute to the growth and evolution of the business – and to leave RLB in an even better position than when I joined.

NS > I think we can all agree with Julian on that!

WHAT DOES IT TAKE TO SUCCEED IN BUSINESS IN YOUR REGION? AND HOW DOES RLB DEMONSTRATE THESE CHARACTERISTICS?

SG > The fundamental principles that underpin RLB globally – creating value for our customers and nurturing partnerships – are all highly valued in the region. Business in the Middle East requires a strong focus on relationship building and earning the trust of our customers. It’s also important to understand that while RLB brings a long history of experience and expertise to the region, there is also a lot that we can learn from the local market to improve our own service offering and ensure that we adapt to suit the requirements of the market. RLB projects in the region are often large, complex and in many cases have national significance. There are many stakeholders with which RLB are required to engage and this requires patience and flexibility. Customers often wish to deal directly with business owners, and the presence of regional directors – who are also owners of the business – strengthens our ability to provide the service that is expected in the market.

HOW DOES RLB ADD VALUE TO ITS TRADITIONAL SERVICE OFFERING?

AB > By remaining relevant, and really understanding our customers’ drivers. You can’t just offer a service. What our customers are paying for is for the effective delivery of their objectives.

I think everyone will agree – none of our services have stood still in the last 10 years – digital technology, off-site manufacturing, smart buildings and a greater awareness of whole-life and sustainability – we’re working in a very different environment now.

Our technical services have kept pace, but ultimately it’s the advice – gained from a wide industry perspective, and backed up with flawless information – that’s what really adds value.

HOW DO GLOBAL MARKETS IMPACT RLB?

AB > At every level I would say. Global customers expect a global service provision, which means that we have to be sure that we're providing a consistent service across the whole of RLB. Global customers don't see territorial boundaries, so we have to collaborate across the business. Global competitors are nimble – they'll happily follow customers from one geographical area to another, so we constantly have to be aware of what's going on – globally and locally.

KK > Globalisation keeps increasing investments across borders. It's true – investors and developers are expecting the same level of services in their home country – with local experience and expertise in their overseas investments and developments.

To cope with this demand, we've been doing our best to establish offices in as many major cities around the world as possible – to connect our people – sharing knowledge and experience. And it's made us stronger.

WHICH PROJECT HAS MADE THE BIGGEST IMPACT ON YOU AND WHY?

AR > The London 2012 Olympics was very special, and so poignant for me. Just seeing that true collaboration.

RL > I agree with Andy, definitely the London 2012 Olympic and Paralympic Games – it was one of the first examples where the global network came together to win a major, high profile bid. We had Sydney experts helping us for three years – they mentored our local team and developed really strong relationships with the customer.

AR > What an achievement. But you know, it's the legacy of the games that's resonated – that's real success to me. It's the £3 billion of inward investment into the community – that's the real, lasting benefit. It's an example of what our industry does best to be honest – seizing an opportunity to build a significant future for a region.

RL > And also it was the springboard for RLB to become the number one cost consultant for major global sports events.

'The London 2012 Olympic and Paralympic Games...it was one of the first examples where the global network came together to win a major, high profile bid.'

RUSSELL LLOYD

IS THERE A PROJECT YOU'VE HAD A CONTINUAL ROLE ON OVER TIME? DESCRIBE IT AND THE ROLE OF RLB'S INVOLVEMENT.

KK > Every project has its challenges, and it takes the whole team to make it successful. But one particularly complex project was a mega scale mixed-use project, developed in several phases.

We were involved from the very beginning – starting from land reclamation. The challenges of such a mega investment are huge – to the developer and everyone else. Several phases of a total of more than 1,000,000 square metres have been completed successfully.

We worked alongside the developer for years – through market changes, government leadership changes, policy changes, personnel changes – but we kept our high quality service all the way through – working with different teams of design consultants and contractors.

WHAT DIFFERENTIATES RLB FROM THE COMPETITION?

NS > The big thing I think is the fact that we're a global practice – most regional businesses are independent.

AR > Well, I could probably identify three main areas. Firstly, our focus and dedication to customers (what we do), the skill and passion of our people (the way we do it) and our independence.

RL > Definitely our independence. Especially in this era of the global acquisition to create mega consultancies.

AR > I agree, the organisational structures of our industry are constantly changing – so being our customers' trusted, independent adviser really does set us apart.

PT > That's right, we've built a reputation as being a 'Trusted Advisor', and as a company with strong values – integrity and honesty, innovation and sustainability, and of course accountability. We're at the forefront of technology so we can meet customers' requirements, and also exceed their expectations.

AR > Also, we take time to understand our customers' objectives. By that I mean we consider the context of our advice within the project and customer environment. We always ask 'what does our advice mean?', it's about addressing the wider objectives while delivering the task at hand. Then there's the skill and passion of our people – it brings our advice to life. We want them to give personal opinions – not just flawless technical advice. This really shows how passionate we are in what we do.

'We've built a reputation as being a 'Trusted Advisor', and as a company with strong values – integrity and honesty, innovation and sustainability, and of course accountability.'

PETER TULLA

HOW DOES RLB PROMOTE THOUGHT LEADERSHIP WITHIN THE INDUSTRY?

KK > Besides our quality service to customers, we get involved in external committees to share our insights and experience.

SL > And you can see this clearly, with many of my colleagues taking up positions in professional bodies and public services – the Hong Kong Institute of Surveyors, Royal Institution of Chartered Surveyors, Construction Industry Council, etc. Take me for example, I was the past President of the Hong Kong Institute of Surveyors and now I'm the Chairman of the Mainland Affairs Committee of the Hong Kong Institute of Surveyors among others.

KK > And from our findings in research and development, we present at conferences – always encouraging dialogue. Through this, and our huge database, we can adapt to the market and make realistic projections for the future.

SL > Also, our RLB Cost Report is one of the most influential construction cost reports in Hong Kong and China's construction industry.

WHEN DID YOU START WORKING FOR RLB? TELL US ABOUT YOUR JOURNEY.

AB > I joined Bucknall Austin as a Senior Project Manager in 1989 – a heady time in the UK construction sector. Over the next 15 years or so I developed a specialism in large-scale social housing and urban renewal schemes. After doing my MBA, I had a relatively traditional path through the business – from team leader to Managing Partner of the Birmingham office. In 2000 the UK adopted a national service delivery model, and I became the UK head of our quantity surveying service – an interesting role for a civil engineering project manager!

By this time Bucknall Austin had been sold to a bigger company, and I eventually became the Managing Director of the professional services division. In 2003 a group of 21 senior staff bought this division, and Bucknall Austin was re-born. I was one of the founder directors and shareholders. In 2006 we were approached to become part of the RLB global practice. When David Bucknall retired in 2012, I was elected as Chairman of the UK business. I took up one of the UK positions on the Global Board and three years later became Global Chairman. Oh, and I also had a couple of children along the way!

‘Along the way, I’ve learnt so much, bringing imagination to life on so many projects, worked with fabulous customers and designers and, really – I’ve been lucky enough to be surrounded by the best people in the business.’

JULIAN ANDERSON

JA > Mine started in 1976, in Brisbane Australia as a Cadet Quantity Surveyor. I then got the opportunity to move to the new Sunshine Coast office (also in Queensland, Australia) and later became office leader. In 1991, I took up the leadership role of our new Hawaii business (with a view to using it as a base for RLB’s expansion to North America).

Along the way, I’ve learnt so much, bringing imagination to life on so many projects, worked with fabulous customers and designers and, really – I’ve been lucky enough to be surrounded by the best people in the business.

AR > After graduating from the University of Salford in Manchester, UK, I joined the business in 2001 as an Associate QS having decided on the choice of a career in property and construction. During my time at RLB, the business has offered a very wide array of opportunities to me, on projects and roles within the business, both in the UK and internationally. My early career within RLB was focused around delivering large projects and supporting Tesco in the UK and internationally, and as a result of this I opened a new office in Welwyn Garden City and grew this quickly into the UK’s national retail sector centre of excellence. I joined the UK Board of Directors in 2014 and from here I was given the opportunity to set up and managed the RLB Euro Alliance, a network of partners in 32 countries supporting our vision to offer truly global expertise in what we do. I was invited to join the Global Board in 2015 and very much value the opportunities to help shape and lead RLB forwards to 2020 and beyond.

SL > I joined in 1989. I became an Associate in the same year and a Partner in 1994. I set up the first few offices for RLB in China in 1994 and also set up the Korea and Oman Offices a few years later. In 2002, I became a Managing Director. So for the past 30 years, I’ve been involved in all aspects of quantity surveying and project management all across Asia, as well as the UK and Africa.

PL > I joined RLB in Hong Kong/China in 1981 – right after graduating from the University of Hong Kong with a first-class honours and a distinction degree. I became an Associate in 1985 and was promoted to a Director/Partner in 1988. I spent 3 years in the Sydney RLB office from 1996, and re-joined RLB in Hong Kong/China as a Director in 1999. I became Managing Director in 2002 and then the Chairman in 2010.

I was also RLB Global Board Chairman from 2013 to 2015.

SM > Well I joined RLB in Sydney in 1983 as a cadet, directly from school. My qualifications as a quantity surveyor came later – from the University of Technology, and a Masters from UNSW.

In the early 90s I worked on the ANA Hotel in Sydney’s CBD, before opening RLB’s Newcastle office – I stayed there for 5 years.

It was there that I cost managed the restoration of the earthquake damaged Christchurch Cathedral – using a unique technique of inserting and grouting stainless steel rods into the existing masonry fabric of the building.

Returning to the Sydney office, I became National Director. Recently I’ve worked on the unique Frank Gehry UTS Business School. I also joined the Marketing Committee and became its Chairman for 10 years – a role I really enjoyed. In 2013 I joined the Executive Committee and in 2014 the RLB Global Board.

I’ve had many mentors along the way, like former Sydney Directors – Damian Judge, John Oliver, Bob Richardson and Greg O’Neill who have been very generous in supporting me throughout my career.



A DECADE OF ACHIEVEMENT ACROSS KEY SECTORS

‘Through the collaborative efforts of the global practice and the skills and passion of our people, RLB has enjoyed remarkable growth and achievements in the last 10 years. Whether it’s the Shanghai Tower, London 2012 Olympics or Sydney Opera House, RLB continues to build on our global knowledge and local expertise as a leader in our industry, helping to shape the places we live, work and play every day.’

ANDREW REYNOLDS
GLOBAL BOARD DIRECTOR

Convention and Exhibition Centres	24
Education and Research	28
Energy	36
Healthcare	38
Hotels and Leisure	42
Infrastructure	46
Mixed Use	50
Offices	56
Public and Civic	62
Residential	68
Retail	74
Sport	78

CONVENTION AND EXHIBITION CENTRES

Convention and exhibition centres are a significant sector for RLB.

The firm's role in these projects has included responsibility as owner's representatives, project managers, cost consultants, schedulers and building life analysts. RLB has effectively served as an extension of the owner's staff for these projects, providing expert project management and cost advice to the entities responsible for the planning, design, construction and long-term operation of these prominent civic buildings.

Expo 2020

DUBAI, UNITED ARAB EMIRATES



CLIENT	CH2M HILL AND MACE PM/CM JV
ARCHITECT	MULTIPLE
SERVICES	COST MANAGEMENT & QUANTITY SURVEYING
COMPLETION	2020





Darwin Waterfront and Convention Centre



DARWIN, AUSTRALIA

CLIENT NORTHERN TERRITORY GOVERNMENT, ABN AMRO

ARCHITECT HASSELL

SERVICES COST MANAGEMENT & QUANTITY SURVEYING

COMPLETION 2008

Hong Kong Convention and Exhibition Centre Atrium Link Extension



HONG KONG, CHINA

CLIENT HONG KONG TRADE DEVELOPMENT COUNCIL

SERVICES COST MANAGEMENT & QUANTITY SURVEYING

COMPLETION 2009



CONVENTION AND EXHIBITION CENTRES

Marina Bay Sands Integrated Resort, including MICE Facilities & Convention Centre

SINGAPORE, SINGAPORE

CLIENT MARINA BAY SANDS PTE LTD
ARCHITECT SAFDIE ARCHITECTS
SERVICES COST MANAGEMENT & QUANTITY SURVEYING
COMPLETION 2010



Moreleta Park Dutch Reformed Church Auditorium

PRETORIA, SOUTH AFRICA

CLIENT NG MORELETA PARK
ARCHITECT E-MARC ARCHITECTS
SERVICES COST MANAGEMENT & QUANTITY SURVEYING
COMPLETION 2009

‘Charl is a great leader and his team willingly follow him. They are great planners.’

PIETER BREYTENBACH
MORELETA PARK, SOUTH AFRICA



Phoenix Convention Center

PHOENIX, NORTH AMERICA

**CLIENT/
ARCHITECT** HOK VENUE AND
LEO A DALY
SERVICES COST MANAGEMENT &
QUANTITY SURVEYING
COMPLETION 2008



Sydney International Convention Exhibition and Entertainment Precinct

SYDNEY, AUSTRALIA

CLIENT CAPELLA CAPITAL
ARCHITECT HASSELL / POPULOUS
SERVICES COST MANAGEMENT &
QUANTITY SURVEYING
COMPLETION 2016



EDUCATION AND RESEARCH

RLB has provided construction consultancy services to many of the world's most prominent research and educational institutions.

The firm offers property expertise across a range of facility types on primary, secondary, college, and university campuses.

Dr Chau Chak Building

SYDNEY, AUSTRALIA



CLIENT	UNIVERSITY OF TECHNOLOGY
ARCHITECT	FRANK GEHRY
SERVICES	COST MANAGEMENT & QUANTITY SURVEYING
COMPLETION	2014



Flinders University Student Hub and Plaza

ADELAIDE, AUSTRALIA

CLIENT FLINDERS UNIVERSITY
ARCHITECT WOODS BAGOT
SERVICES COST MANAGEMENT &
QUANTITY SURVEYING
COMPLETION 2016



Hong Kong Science Park Phase 3 Development

HONG KONG, CHINA

CLIENT HONG KONG SCIENCE &
TECHNOLOGY
PARKS CORPORATION
ARCHITECT SIMON KWAN &
ASSOCIATES LIMITED
SERVICES COST MANAGEMENT &
QUANTITY SURVEYING
COMPLETION 2016



EDUCATION AND RESEARCH

Khalifa University Extension

ABU DHABI, UNITED ARAB EMIRATES

CLIENT KHALIFA UNIVERSITY ARCHITECTS
PLANNERS AND ENGINEERS

ARCHITECT RSP ARCHITECTS PLANNERS
AND ENGINEERS

SERVICES COST MANAGEMENT &
QUANTITY SURVEYING

COMPLETION 2016



LASALLE College of the Arts

SINGAPORE, SINGAPORE

CLIENT LASALLE COLLEGE OF THE ARTS

ARCHITECT RSP ARCHITECTS

SERVICES COST MANAGEMENT &
QUANTITY SURVEYING, ADVISORY

COMPLETION 2008

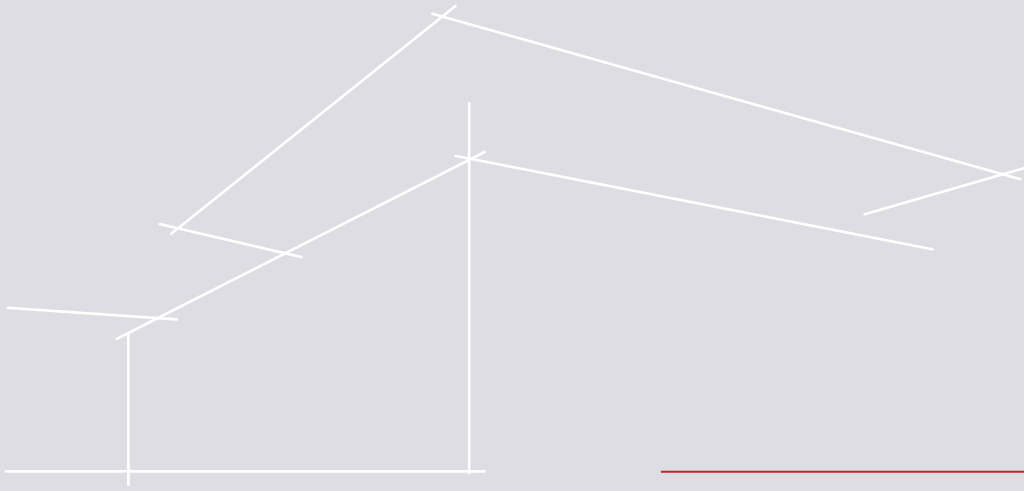

National Automotive Innovation Centre



COVENTRY, UNITED KINGDOM

CLIENT	UNIVERSITY OF WARWICK
ARCHITECT	CULLINAN STUDIO
SERVICES	COST MANAGEMENT & QUANTITY SURVEYING
STAKEHOLDERS	JAGUAR LAND ROVER, TATA MOTORS EUROPEAN TECHNICAL CENTRE, WMG AND THE UNIVERSITY OF WARWICK
COMPLETION	2018



Photography - Cullinan Studio

EDUCATION AND RESEARCH

Oregon State University, Learning Innovation Center

CORVALLIS, NORTH AMERICA

CLIENT/
ARCHITECT BORA ARCHITECTS

SERVICES COST MANAGEMENT &
QUANTITY SURVEYING, ADVISORY

COMPLETION 2015

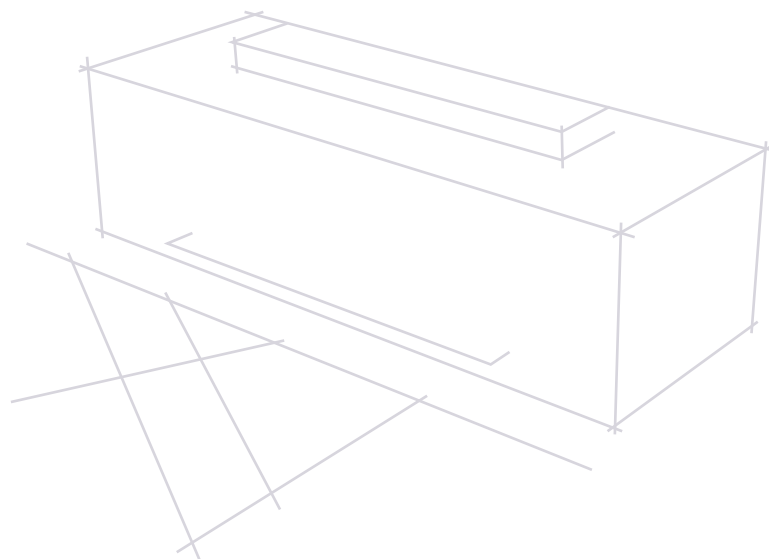



Antarctica New Zealand Pictorial Collection, 2015-16
Photography - Jenny Ryan ©

Scott Base, Hillary Field Centre



ANTARCTICA

- CLIENT** ANTARCTICA NEW ZEALAND
- ARCHITECT** LABWORKS ARCHITECTURE
- SERVICES** COST MANAGEMENT & QUANTITY SURVEYING
- COMPLETION** 2017



EDUCATION AND RESEARCH

South Australian Health and Medical Research Institute



ADELAIDE, AUSTRALIA

CLIENT SA HEALTH MAJOR
PROJECTS OFFICE

ARCHITECT WOODS BAGOT

SERVICES COST MANAGEMENT & QUANTITY
SURVEYING, ADVISORY

COMPLETION 2013

‘Daniel put an extraordinary
level of dedication into
finalising project costs.’

AUGUSTA SOTERIOU,
SOUTH AUSTRALIAN DEPARTMENT OF PLANNING,
TRANSPORT AND INFRASTRUCTURE, AUSTRALIA





University of Pretoria Engineering Faculty



PRETORIA, SOUTH AFRICA

CLIENT	UNIVERSITY OF PRETORIA
ARCHITECT	ARC ARCHITECTS
SERVICES	COST MANAGEMENT & QUANTITY SURVEYING
COMPLETION	2011

Yale-NUS College



SINGAPORE, SINGAPORE

CLIENT	YALE UNIVERSITY AND NATIONAL UNIVERSITY OF SINGAPORE
ARCHITECT	FORUM ARCHITECTS (SINGAPORE) AND PELLI CLARKE PELLI ARCHITECTS (USA)
SERVICES	COST MANAGEMENT & QUANTITY SURVEYING
COMPLETION	2015



ENERGY

At RLB, we have significant experience in delivering consultancy services within the energy sector, with specific focus and expertise in both nuclear new-build and decommissioning works.

Our core services of commercial management, contract management and project controls ensure that we effectively manage value and safety in this challenging sector.

MTN Centurion Switch Phase 2



JOHANNESBURG, SOUTH AFRICA

CLIENT	MTN
ARCHITECT	PROJECTWORKS
SERVICES	COST MANAGEMENT & QUANTITY SURVEYING
COMPLETION	2016

Humboldt Bay Nuclear Power Plant Decommissioning



HUMBOLDT BAY, NORTH AMERICA

SERVICES	ADVISORY
COMPLETION	2013



‘RLB displayed a proactive approach to cooperative relations with us.’

MTN, FAIRLAND, JOHANNESBURG



Olkiluoto 3

OLKILUOTO ISLAND, FINLAND



CLIENT	AREVA, FINLAND
ARCHITECT	SIMON KWAN & ASSOCIATES LIMITED
SERVICES	COST MANAGEMENT & QUANTITY SURVEYING
COMPLETION	2013



HEALTHCARE

We have assisted in the delivery of a number of hospitals, health centres, and clinics for both the private and public sectors across the world.

RLB's healthcare experts have a clear understanding of the intricacies involved in the delivery and operation of major and complex health projects.

Burwood Hospital Redevelopment



CHRISTCHURCH, NEW ZEALAND

CLIENT	MINISTRY OF HEALTH AND CANTERBURY DISTRICT HEALTH BOARD
ARCHITECT	JASMAX, KLEIN AND SHEPPARD AND ROUT IN ASSOCIATION
SERVICES	COST MANAGEMENT & QUANTITY SURVEYING
COMPLETION	2016

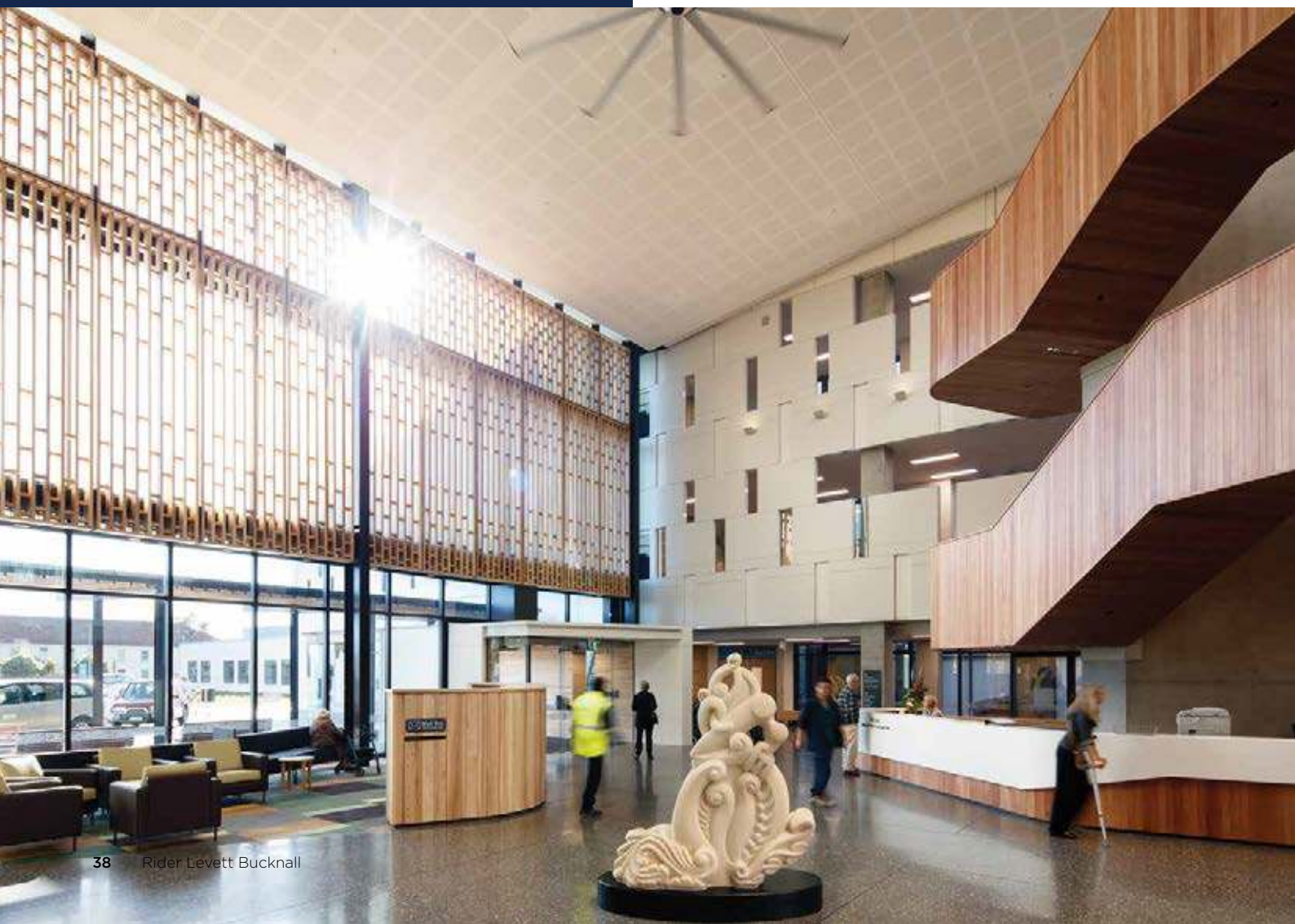

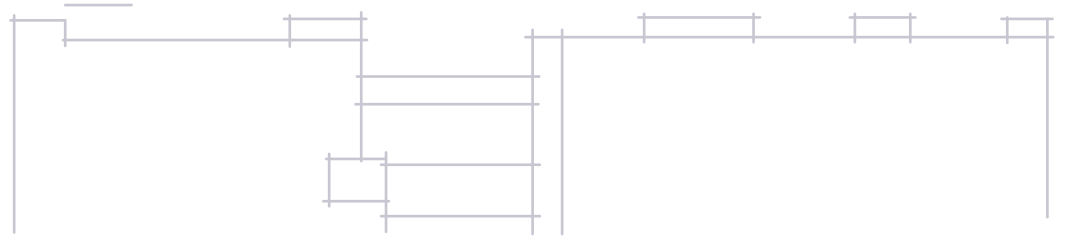

Hong Kong Children's Hospital

HONG KONG, CHINA

CLIENT THE GOVERNMENT OF THE HKSAR
ARCHITECT ARCHITECTURAL SERVICES DEPARTMENT OF THE GOVERNMENT OF THE HKSAR, SIMON KWAN & ASSOCIATES LIMITED
SERVICES COST MANAGEMENT & QUANTITY SURVEYING
COMPLETION 2017



Job Shimankana Tabane Hospital

RUSTENBURG, SOUTH AFRICA

CLIENT DEPARTMENT OF HEALTH - NORTH WEST
ARCHITECT MTM ARCHITECTS
SERVICES COST MANAGEMENT & QUANTITY SURVEYING
COMPLETION 2017



'RLB acted with outstanding professionalism and their services were exemplary in every aspect.'

KOENA PHOKELA,
 DEPARTMENT OF HEALTH, SOUTH AFRICA

HEALTHCARE

New Emergency Floor, University Hospitals of Leicester



LEICESTER, UNITED KINGDOM

CLIENT UNIVERSITY HOSPITALS OF
LEICESTER NHS TRUST

ARCHITECT CAPITA

SERVICES COST MANAGEMENT &
QUANTITY SURVEYING,
PROJECT MANAGEMENT

COMPLETION 2017



Photography - Capita



King Fahad Medical City



RIYADH, KINGDOM OF SAUDI ARABIA

CLIENT MINISTRY OF HEALTH

ARCHITECT HKS

SERVICES COST MANAGEMENT &
QUANTITY SURVEYING

COMPLETION 2016

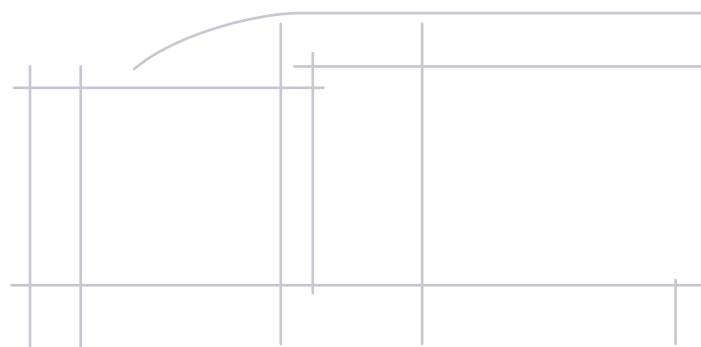

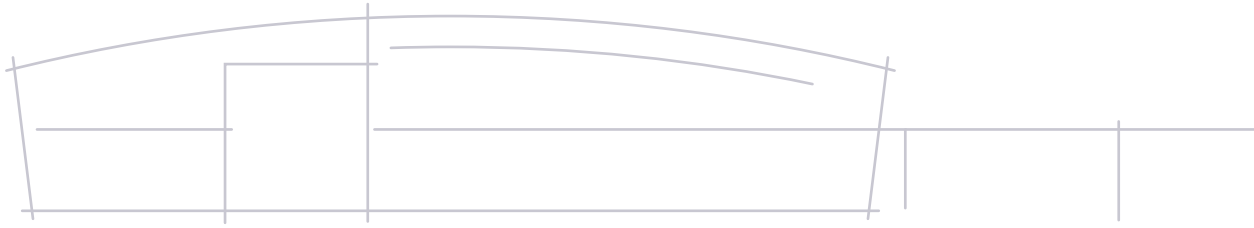

**Samuel Simmonds
Memorial Hospital,**
BARROW, NORTH AMERICA



CLIENT ARCTIC SLOPE
NATIVE ASSOCIATION

ARCHITECT RIM ARCHITECTS

SERVICES COST MANAGEMENT &
QUANTITY SURVEYING,
PROJECT MANAGEMENT

COMPLETION 2013

**Sunshine Coast
University Hospital**
SUNSHINE COAST, AUSTRALIA



CLIENT QUEENSLAND DEPARTMENT
OF HEALTH

ARCHITECT ARCHITECTUS/RICE DAUBNEY

SERVICES COST MANAGEMENT &
QUANTITY SURVEYING, ADVISORY

COMPLETION 2017



HOTELS AND LEISURE

We support hotel investors, developers, operators and brand managers to develop new hotels and refurbish existing ones.

RLB has provided a full range of project management, cost consulting and advisory services on hospitality developments across the globe. We have the experience to ensure success on large scale, phased developments, as well as intricate improvement programs at operational hotel and resort properties.

Four Seasons Resort O'ahu at Ko Olina



KAPOLEI, NORTH AMERICA

CLIENT	KO OLINA, HAWAII
ARCHITECT	GROUP 70 & DE REUS ARCHITECTS
SERVICES	COST MANAGEMENT & QUANTITY SURVEYING, PROJECT MANAGEMENT
COMPLETION	2016





Marina Bay Sands Integrated Resort including MICE Facilities & Convention Centre

SINGAPORE, SINGAPORE

CLIENT	MARINA BAY SANDS PTE LTD
ARCHITECT	SAFDIE ARCHITECTS
SERVICES	COST MANAGEMENT & QUANTITY SURVEYING
COMPLETION	2010

Macau Cotai Venetian Parcel 1, 2, 5, 6 Development

MACAU, CHINA

CLIENT	VENETIAN MACAU LIMITED
ARCHITECT	AEDAS
SERVICES	COST MANAGEMENT & QUANTITY SURVEYING
COMPLETION	2016

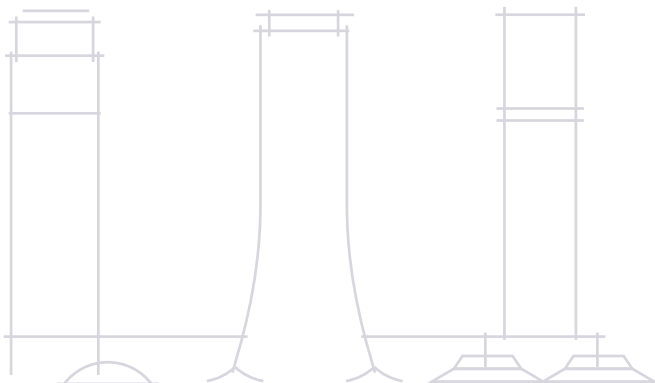

HOTELS AND LEISURE

State Building, Como Hotel



PERTH, AUSTRALIA

CLIENT FJM PROPERTY
ARCHITECT KERRY HILL ARCHITECTS/
PALASSIS ARCHITECTS
SERVICES COST MANAGEMENT &
QUANTITY SURVEYING
COMPLETION 2015

‘RLB’s ongoing efforts and acumen ensured the project progressed with certainty.’

KYLE JEAVONS,
FJM PROPERTY, PERTH, AUSTRALIA



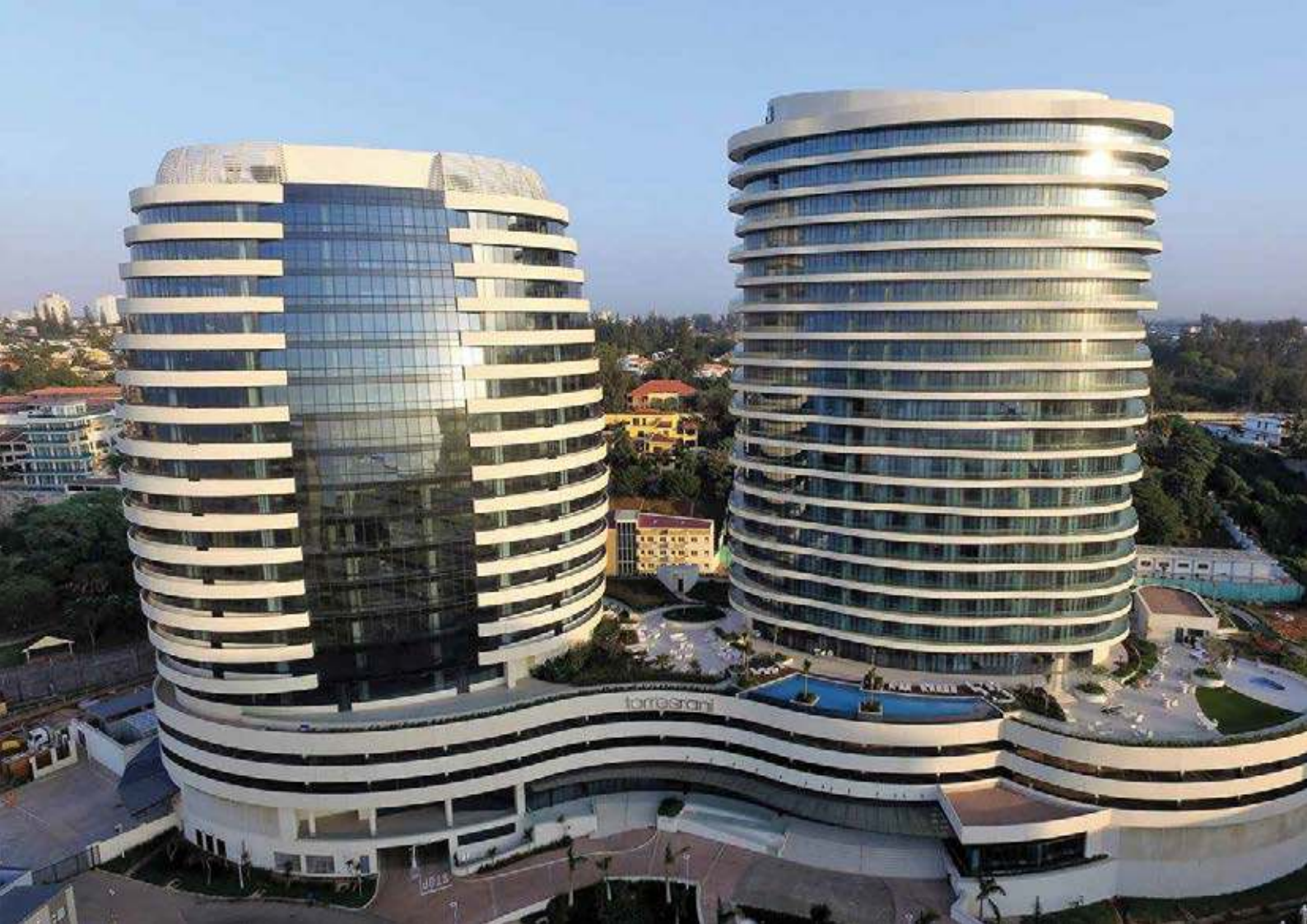

Rani Torres (Horizon)

MAPUTO, MOZAMBIQUE



CLIENT	RANI
ARCHITECT	DSA ARCHITECTS
SERVICES	COST MANAGEMENT & QUANTITY SURVEYING
COMPLETION	2017

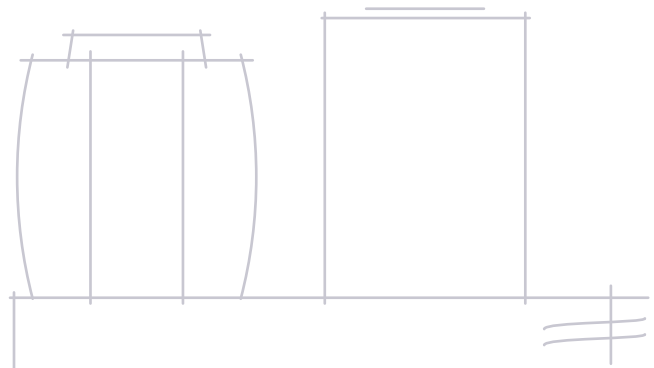

The Address Residence Fountain Views

DUBAI, UNITED ARAB EMIRATES



CLIENT	EMAAR PROPERTIES
ARCHITECT	DEWAN ARCHITECTS + ENGINEERS.
SERVICES	COST MANAGEMENT & QUANTITY SURVEYING
COMPLETION	2018



INFRASTRUCTURE

RLB supports the transportation, mining, water and refining sectors across the world.

The firm has provided construction consultancy services to both public and private entities, advising customers on cost and time of infrastructure and resource development projects.

Infrastructure is the backbone of our future economic success, it requires intelligent solutions and innovative implementation techniques. Delivered successfully, not only will we reap the economic gains but it will increase productivity growth, support our growing population, sustain industries, enhance social wellbeing and connect urban and rural environments.

Auckland City Rail Link



AUCKLAND, NEW ZEALAND

CLIENT	AUCKLAND TRANSPORT/ CITY RAIL LINK LTD
ARCHITECT	AURECON GROUP, IN ASSOCIATION WITH: MOTT MACDONALD, JASMAX ARCHITECTS, GRIMSHAW, ARUP
SERVICES	COST MANAGEMENT & QUANTITY SURVEYING, ADVISORY
COMPLETION	2023/24



Bluewaters

DUBAI, UNITED ARAB EMIRATES



CLIENT MERAAS HOLDING/MIRAGE
LEISURE & DEVELOPMENT

ARCHITECT MULTIPLE

SERVICES COST MANAGEMENT &
QUANTITY SURVEYING

COMPLETION 2018



iPort Rail

DONCASTER, UNITED KINGDOM



CLIENT ROSSINGTON RFF LTD

ARCHITECT AJA ARCHITECTS LTD

SERVICES COST MANAGEMENT &
QUANTITY SURVEYING

COMPLETION 2017

INFRASTRUCTURE

Marina Bay Sands District Cooling Plant



SINGAPORE, SINGAPORE

CLIENT MARINA BAY SANDS PTE LTD
ARCHITECT SCREEN FAÇADE BY ARTIST NED KAHN
SERVICES COST MANAGEMENT & QUANTITY SURVEYING
COMPLETION 2010

Portland International Jetport



PORTLAND, NORTH AMERICA

CLIENT GENSLER
SERVICES COST MANAGEMENT & QUANTITY SURVEYING
COMPLETION 2011





MIXED USE

RLB has been involved in a significant number of mixed-use developments, encompassing a range of buildings from hotels, residential and retail to office and entertainment.

The firm is accustomed to working on complex mixed-use developments that embody a range of requirements and considerations for each unique building type.

CityCenter

LAS VEGAS, NORTH AMERICA



CLIENT/ ARCHITECT	GENSLER
SERVICES	COST MANAGEMENT & QUANTITY SURVEYING
COMPLETION	2009



‘Given RLB’s early involvement, we were able to move ahead with the confidence required to deliver.’

VICTOR ISTANTO, CBUS PROPERTY,
MELBOURNE, AUSTRALIA



Photography - Phillip Vile

Collins Arch, 447 Collins Street MELBOURNE, AUSTRALIA



CLIENT	CBUS PROPERTY
ARCHITECT	WOODS BAGOT/ SHOP ARCHITECTS
SERVICES	COST MANAGEMENT & QUANTITY SURVEYING
COMPLETION	2019

Hallsville Quarter LONDON, UNITED KINGDOM



CLIENT	LINKCITY
ARCHITECT	HAWORTH TOMPKINS LIMITED
SERVICES	COST MANAGEMENT & QUANTITY SURVEYING
COMPLETION	2020

MIXED USE

Jeddah Tower

JEDDAH, KINGDOM OF SAUDI ARABIA

CLIENT CONFIDENTIAL
ARCHITECT ADRIAN SMITH + GORDON GILL
ARCHITECTURE (AS + GG)
SERVICES ADVISORY
COMPLETION 2019



Marina Bay Sands Integrated Resort including MICE Facilities & Convention Centre

SINGAPORE, SINGAPORE

CLIENT MARINA BAY SANDS PTE LTD
ARCHITECT SAFDIE ARCHITECTS
SERVICES COST MANAGEMENT & QUANTITY SURVEYING
COMPLETION 2010



Menlyn Maine Central Square Precinct

PRETORIA, SOUTH AFRICA

CLIENT MENLYN MAINE
ARCHITECT BOOGERTMAN & PARTNERS
SERVICES COST MANAGEMENT & QUANTITY SURVEYING
COMPLETION 2016

MIXED USE



Shanghai Tower

SHANGHAI, CHINA



CLIENT SHANGHAI TOWER CONSTRUCTION AND DEVELOPMENT COMPANY LIMITED

ARCHITECT GENSLER

SERVICES COST MANAGEMENT & QUANTITY SURVEYING

COMPLETION 2016



Msheireb Downtown Doha

DOHA, QATAR



CLIENT MSHEIREB PROPERTIES

ARCHITECT MULTIPLE

SERVICES COST MANAGEMENT & QUANTITY SURVEYING

COMPLETION 2019



OFFICES

RLB works closely with developers, investors and building owners to deliver new-build, refurbishment, office fit-out and mixed-use projects.

Our customers in this sector have included leading developers, portfolio holders and occupiers.

We deliver services for everything from one-off developments, to asset management strategies for national and international property portfolios.

Our focus is on the key business drivers for our customers. We have helped customers develop high quality buildings to ensure successful financial returns for investors as well as assisted in delivering excellent office space, which attracts occupiers and operates effectively throughout the asset's lifetime.

ASIO HQ Offices, Ben Chifley Building



CANBERRA, AUSTRALIA

CLIENT	DEPARTMENT OF FINANCE
ARCHITECT	FRANCIS-JONES MOREHEN THORP (FJMT)
SERVICES	COST MANAGEMENT & QUANTITY SURVEYING
COMPLETION	2015

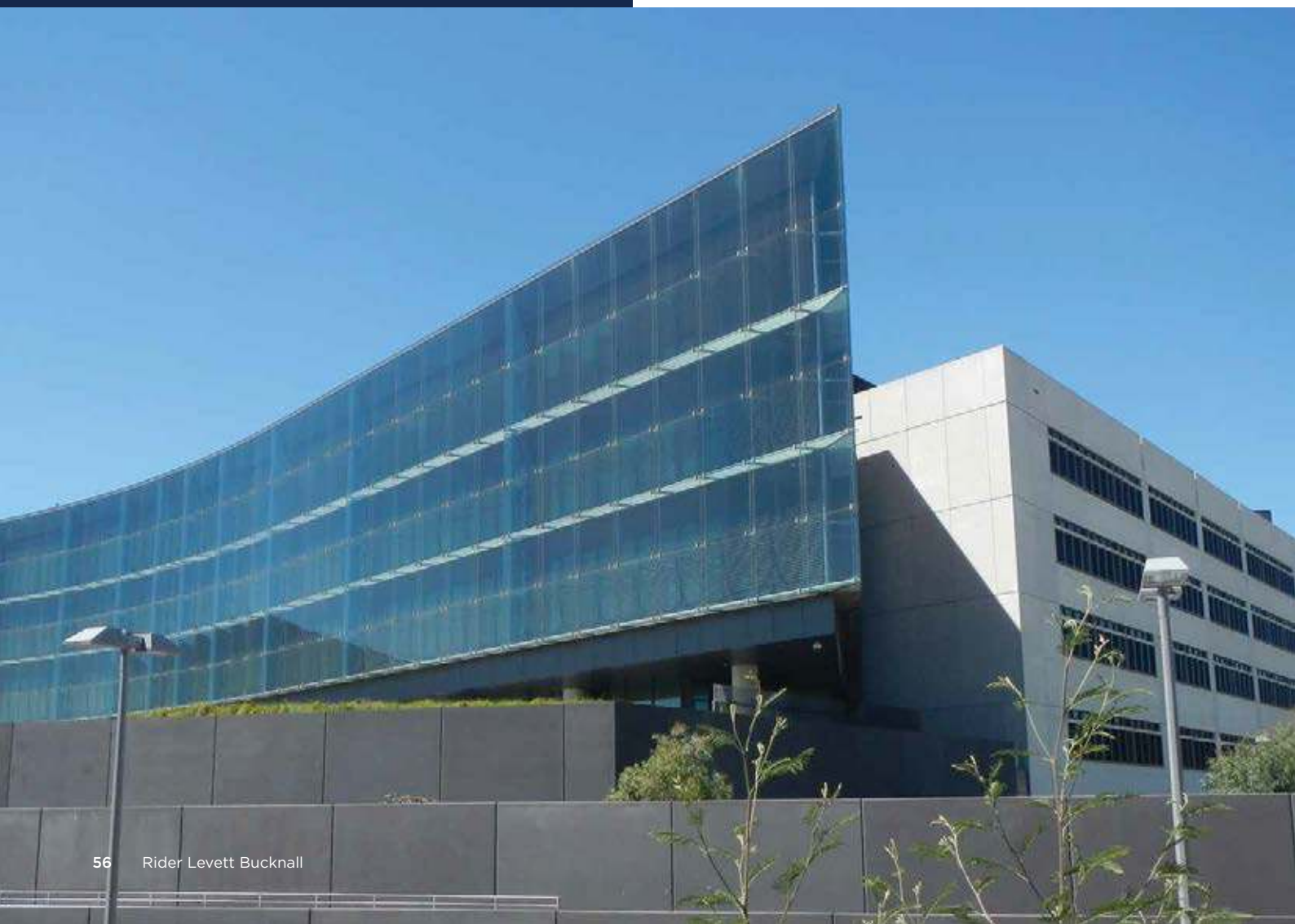



Brookfield Place Towers 1 & 2

PERTH, AUSTRALIA

CLIENT	BROOKFIELD OFFICE PROPERTIES
ARCHITECT	HASELL
SERVICES	COST MANAGEMENT & QUANTITY SURVEYING
COMPLETION	2012

d3 Creative Community

DUBAI, UNITED ARAB EMIRATES

CLIENT	TECOM INVESTMENTS
ARCHITECT	FOSTER + PARTNERS
SERVICES	COST MANAGEMENT & QUANTITY SURVEYING
COMPLETION	2018



OFFICES

Discovery Head Office

SANDTON, SOUTH AFRICA



CLIENT GROWTHPOINT PROPERTIES AND ZENPROP
ARCHITECT BOOGERTMAN & PARTNERS
SERVICES COST MANAGEMENT & QUANTITY SURVEYING
COMPLETION 2017

‘The challenges during the project were always handled with due care and delivery was achieved on all fronts.’

PIETER VAN WYK,
ZENPROP PROPERTY HOLDINGS, SOUTH AFRICA



Ping An Finance Centre

SHENZHEN, CHINA



CLIENT PING AN INSURANCE GROUP
ARCHITECT KOHN PEDERSEN FOX ASSOCIATES
SERVICES COST MANAGEMENT & QUANTITY SURVEYING
COMPLETION 2016



PS100/Oasia Downtown

SINGAPORE, SINGAPORE



CLIENT FAR EAST ORGANISATION
ARCHITECT WOHA
SERVICES COST MANAGEMENT &
QUANTITY SURVEYING
COMPLETION 2016



Snowhill

BIRMINGHAM, UNITED KINGDOM



CLIENT CONFIDENTIAL
ARCHITECT ONE SNOWHILL: KPMP- MCM ARCHITECTS
TWO SNOWHILL: WRAGGE LAWRENCE & CO-
GENSLER ARCHITECTS
SERVICES COST MANAGEMENT &
QUANTITY SURVEYING
COMPLETION 2013

OFFICES

Tower at PNC Plaza

BOSTON, NORTH AMERICA

**CLIENT/
ARCHITECT** GENSLER
SERVICES COST MANAGEMENT &
QUANTITY SURVEYING
COMPLETION 2015

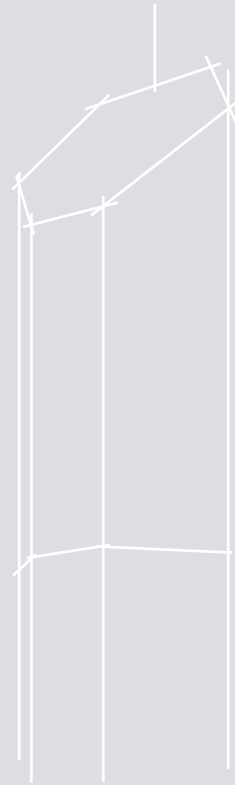

1 William Street

BRISBANE, AUSTRALIA

CLIENT PROJECTS QUEENSLAND
ARCHITECT WOODS BAGOT
SERVICES COST MANAGEMENT &
QUANTITY SURVEYING
COMPLETION 2017





PUBLIC AND CIVIC

Having worked with numerous governments and other stakeholders of major public and civic projects, RLB has a clear understanding of the processes, regulations and requirements to ensure project success.

Agrivaal

PRETORIA, SOUTH AFRICA



CLIENT	DEPARTMENT OF PUBLIC WORKS
ARCHITECT	PKA INTERNATIONAL ARCHITECTS
SERVICES	COST MANAGEMENT & QUANTITY SURVEYING
COMPLETION	2016

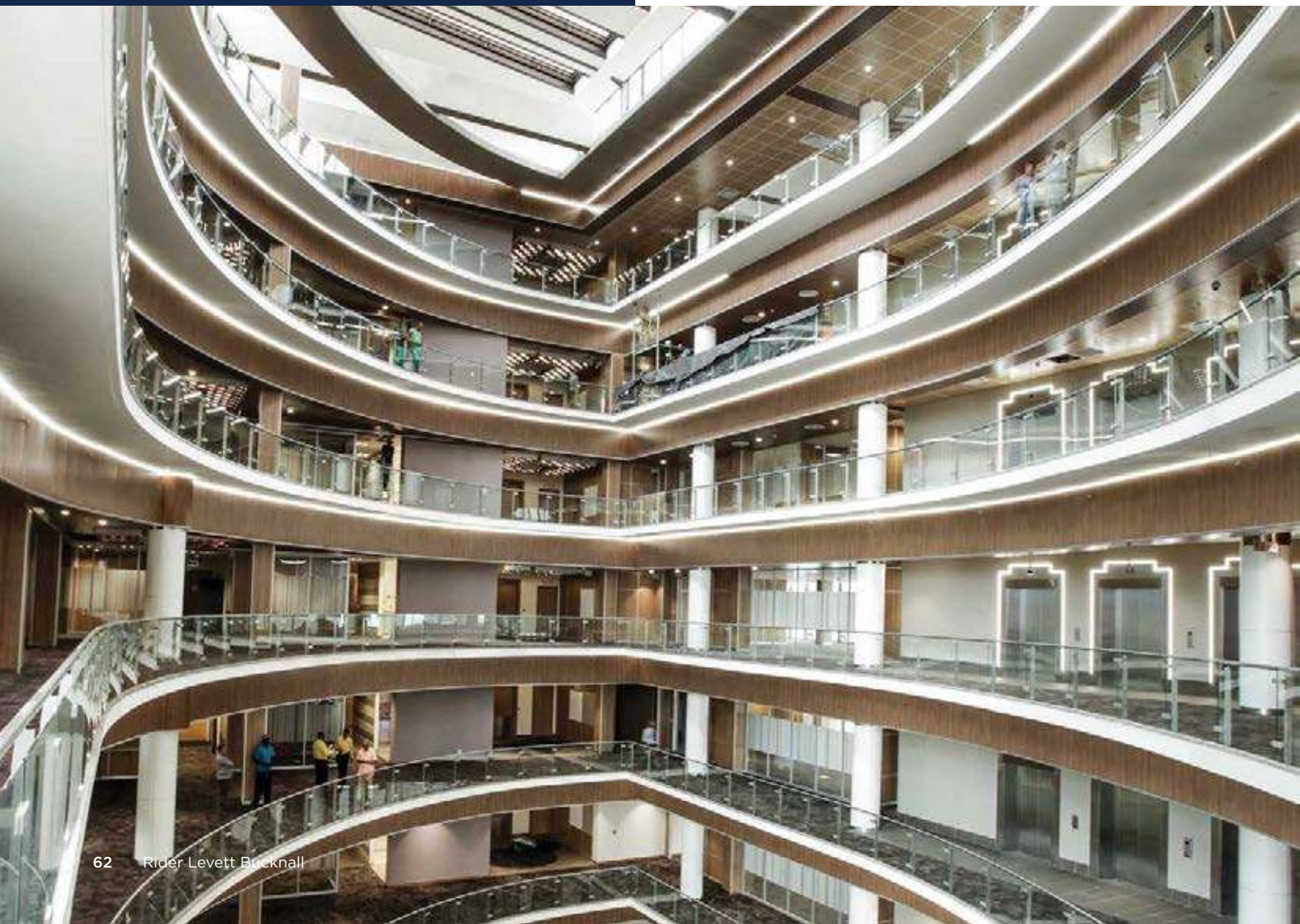

Edith Green Wendell Wyatt Federal Building



PORTLAND, NORTH AMERICA

**CLIENT/
ARCHITECT** SERA ARCHITECTS INC.
SERVICES COST MANAGEMENT &
QUANTITY SURVEYING
COMPLETION 2013



Len Lye Centre & Govett-Brewster Art Gallery



NEW PLYMOUTH, NEW ZEALAND

CLIENT NEW PLYMOUTH
DISTRICT COUNCIL
ARCHITECT PATTERSON ASSOCIATES
SERVICES COST MANAGEMENT &
QUANTITY SURVEYING
COMPLETION 2015

‘I found RLB’s personnel to be proactive, entrepreneurial and committed to creating long-term value.’

GAYE BATTY,
NEW PLYMOUTH DISTRICT COUNCIL,
NEW ZEALAND

PUBLIC AND CIVIC

Louvre Abu Dhabi



ABU DHABI, UNITED ARAB EMIRATES

CLIENT TOURISM DEVELOPMENT &
INVESTMENT COMPANY (TDIC),

ARCHITECT JEAN NOUVEL

SERVICES COST MANAGEMENT &
QUANTITY SURVEYING

COMPLETION 2017

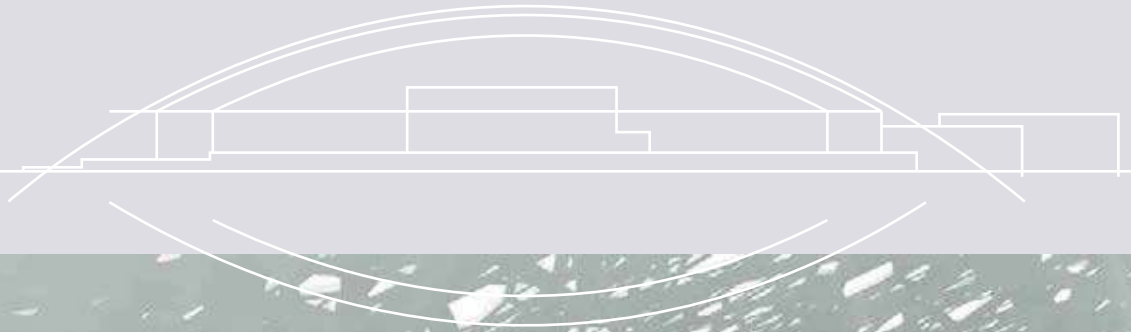



Museum of Old and New Art

HOBART, AUSTRALIA

CLIENT	MUSEUM OF NEW AND OLD ART
ARCHITECT	FENDER KATSALIDIS ARCHITECTS
SERVICES	COST MANAGEMENT & QUANTITY SURVEYING
COMPLETION	2011



PUBLIC AND CIVIC

Sir John Monash Centre

VILLERS-BRETONNEUX, FRANCE

CLIENT DEPARTMENT OF VETERANS' AFFAIRS
ARCHITECT COX ARCHITECTURE
SERVICES COST MANAGEMENT & QUANTITY SURVEYING
COMPLETION 2018



The Look Out Hyde Park Project

LONDON, UNITED KINGDOM

CLIENT THE ROYAL PARKS
ARCHITECT DAVID MORLEY ARCHITECTS
SERVICES COST MANAGEMENT &
QUANTITY SURVEYING,
PROJECT MANAGEMENT
COMPLETION 2011



Xiqu Centre, West Kowloon Cultural District

HONG KONG, CHINA

CLIENT WEST KOWLOON CULTURAL
DISTRICT AUTHORITY
ARCHITECT BING THOM ARCHITECTS,
AND RONALD LU & PARTNERS
COMPANY LIMITED
SERVICES COST MANAGEMENT &
QUANTITY SURVEYING
COMPLETION 2018



RESIDENTIAL

RLB has worked on a range of residential projects from single-family homes to the tallest residential towers in the world.

Our breadth of experience also captures social housing, regeneration and residential led mixed-use developments.

Burlingame Ranch



ASPEN, NORTH AMERICA

CLIENT	CITY OF ASPEN
ARCHITECT	OZ ARCHITECTURE
SERVICES	COST MANAGEMENT & QUANTITY SURVEYING, PROJECT MANAGEMENT
COMPLETION	2015



Clyde Quay Wharf

WELLINGTON, NEW ZEALAND



CLIENT WILLIS BOND
ARCHITECT ATHFIELD ARCHITECTS
SERVICES COST MANAGEMENT & QUANTITY SURVEYING
COMPLETION 2014



Lusail City

DOHAR, QATAR



CLIENT LUSAIL REAL ESTATE DEVELOPMENT COMPANY (LREDC)
ARCHITECT MULTIPLE
SERVICES COST MANAGEMENT & QUANTITY SURVEYING
COMPLETION 2022

RESIDENTIAL

Opus

HONG KONG, CHINA

CLIENT SWIRE PROPERTIES
ARCHITECT GEHRY PARTNERS
SERVICES COST MANAGEMENT &
QUANTITY SURVEYING
COMPLETION 2012



‘RLB always carried out their duties in a highly competent manner.’

**ROBERT LEVETT,
SWIRE PROPERTIES LIMITED,
HONG KONG, CHINA**

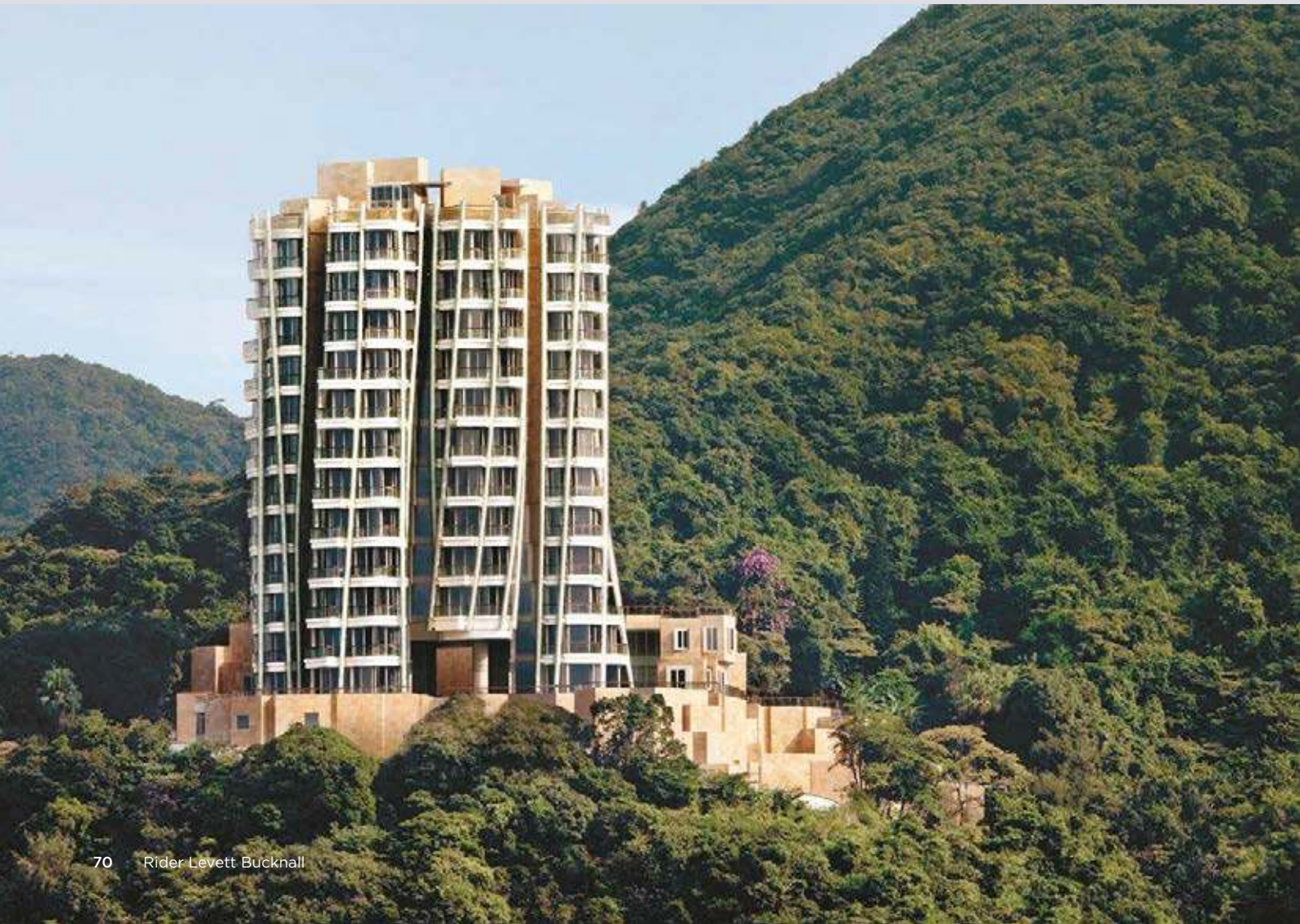

Rani Torres (Horizon)

MAPUTO, MOZAMBIQUE



CLIENT RANI
ARCHITECT DSA ARCHITECTS
SERVICES COST MANAGEMENT &
QUANTITY SURVEYING
COMPLETION 2016



Photography - ©Tim Crocker

Rathone Market Regeneration

LONDON, UNITED KINGDOM



CLIENT ENGLISH CITIES FUND
ARCHITECT CZWG ARCHITECTS LLP
SERVICES COST MANAGEMENT &
QUANTITY SURVEYING
COMPLETION 2017

RESIDENTIAL

The Address Residence Fountain Views



DUBAI, UNITED ARAB EMIRATES

CLIENT EMAAR PROPERTIES
ARCHITECT DEWAN ARCHITECTS + ENGINEERS.
SERVICES COST MANAGEMENT & QUANTITY SURVEYING
COMPLETION 2018

Trilogy Towers



PRETORIA, SOUTH AFRICA

CLIENT MENLYN MAINE
ARCHITECT GLH ARCHITECTS
SERVICES COST MANAGEMENT & QUANTITY SURVEYING
COMPLETION 2019

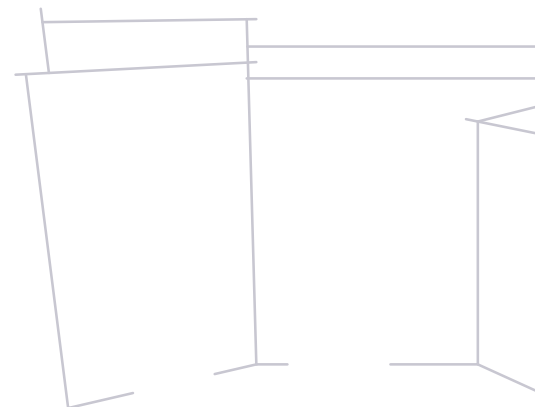



RETAIL

We understand that our customers' priority and concern is providing maximum returns and value from their retail developments.

In order to achieve this, projects must be delivered in a fast, economical, tax efficient manner and to a predetermined quality. RLB, having worked with some of the world's major developers and retailers, has the experience to help achieve this.

Deira Island Mall



DUBAI, UNITED ARAB EMIRATES

CLIENT	NAKHEEL PROPERTIES
ARCHITECT	RSP ARCHITECTS PLANNERS AND ENGINEERS
SERVICES	COST MANAGEMENT & QUANTITY SURVEYING
COMPLETION	2020

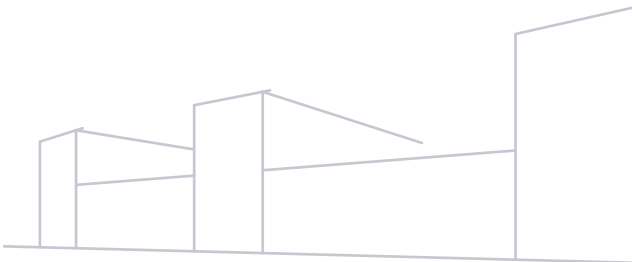

Menlyn Maine Central Square

PRETORIA, SOUTH AFRICA



CLIENT MENLYN MAINE
ARCHITECT BOOGERTMAN & PARTNERS
SERVICES COST MANAGEMENT &
QUANTITY SURVEYING
COMPLETION 2016



Riverside 66

TIANJIN, CHINA



CLIENT HANG LUNG (TIANJIN) LIMITED
ARCHITECT KOHN PENDERSON FOX
ASSOCIATES PC (DESIGN
ARCHITECT), P&T ARCHITECTS &
ENGINEERS LIMITED (ARCHITECT)
SERVICES COST MANAGEMENT &
QUANTITY SURVEYING
COMPLETION 2014

‘Throughout the project
RLB’s commitment has been
commendable and diligent.’

SABRINA LAW,
TIANJIN HANG LUNG PROPERTIES,
TIANJIN, CHINA

RETAIL

The Crossing

CHRISTCHURCH, NEW ZEALAND

CLIENT AB INVESTMENTS LTD
ARCHITECT WILSON & HILL
SERVICES COST MANAGEMENT &
QUANTITY SURVEYING
COMPLETION 2017



Transforming Tesco

UNITED KINGDOM

CLIENT TESCO PLC
ARCHITECT TESCO PLC
SERVICES COST MANAGEMENT &
QUANTITY SURVEYING,
PROJECT MANAGEMENT
COMPLETION 2017





Westfield University Town Center



LA JOLLA, NORTH AMERICA

CLIENT	WESTFIELD
SERVICES	COST MANAGEMENT & QUANTITY SURVEYING
COMPLETION	2012



SPORT

RLB has provided cost management services on the delivery of some of the world's most prestigious stadiums, arenas and major sporting events.

RLB's sports team understands the varying delivery requirements for this sector and is adept at delivering on time and on budget. Our involvement and experience on both permanent and temporary event facilities, enables us to help our customers deliver the most efficient and cost effective sports projects.

Atlanta Falcons NFL Stadium

ATLANTA, NORTH AMERICA

CLIENT	ICON VENUE GROUP
ARCHITECT	HOK
SERVICES	COST MANAGEMENT & QUANTITY SURVEYING
COMPLETION	2017





Adelaide Oval Redevelopment



ADELAIDE, AUSTRALIA

CLIENT	ADELAIDE OVAL STADIUM MANAGEMENT AUTHORITY
ARCHITECT	COX ARCHITECTS/WALTER BROOKE/HAMES SHARLEY
SERVICES	COST MANAGEMENT & QUANTITY SURVEYING, ADVISORY
COMPLETION	2014

King Abdullah Sports City



JEDDAH, KINGDOM OF SAUDI ARABIA

CLIENT	SAUDI ARAMCO
ARCHITECT	POPULOUS ARCHITECTS
SERVICES	COST MANAGEMENT & QUANTITY SURVEYING
COMPLETION	2014



SPORT

London 2012 Olympic and Paralympic Games

LONDON, UNITED KINGDOM

CLIENT	THE LONDON ORGANISING COMMITTEE FOR THE OLYMPIC AND PARALYMPIC GAMES
ARCHITECT	TEAM POPULOUS
PROJECT MANAGER	EVENT PLANNING GROUP
SERVICES	COST MANAGEMENT & QUANTITY SURVEYING, PROJECT MANAGEMENT, HEALTH & SAFETY
COMPLETION	2012



‘We are tremendously grateful for your support which contributed to the success of the London 2012 Olympic Games and Paralympic Games.’

**SEBASTIAN COE, KBE,
LONDON ORGANISING COMMITTEE,
LONDON, UNITED KINGDOM**





Olympic Equestrian Venues 2008

HONG KONG, CHINA

CLIENT	THE HONG KONG JOCKEY CLUB
ARCHITECT	TIM COURT & COMPANY (CONCEPT ARCHITECT), AND RONALD LU & PARTNERS
SERVICES	COST MANAGEMENT & QUANTITY SURVEYING
COMPLETION	2008

Singapore Sports Hub

SINGAPORE, SINGAPORE

CLIENT	SPORT SINGAPORE AND SPORTS HUB PTE LTD (PPP)
ARCHITECT	ARUP SPORT (SPORTS VENUES), DP ARCHITECTS (NON-SPORT VENUES, QP), AECOM (LANDSCAPE)
SERVICES	COST MANAGEMENT & QUANTITY SURVEYING, PROJECT MANAGEMENT
COMPLETION	2014





The projects represented here are testament to the many partnerships and friendships that have been central to our success.

In 2017, as we consider the projects RLB is presently involved in, we look forward to the strengthening of these relationships.





As we bring new projects to life, we will continue to contribute to the future direction of major cities across the globe over the next decade. RLB takes great pride in being associated with all of these projects.



